

# AIR VELOCITY TRANSMITTER



## Features

### AVT 251 and AVT 551

- Ranges  
AVT 251: 0-5 m/s, 0-10 m/s, 0-15 m/s or 0-20 m/s  
AVT 551: 0-1 m/s, 0-2 m/s, 0-3 m/s or 0-5 m/s  
DIP switches selectable
- Two outputs for Air Velocity  
4-20 mA and 0-10 Vdc
- Accuracy Air Velocity  
 $\pm 5\%$  for 0-20 m/s
- Response time 1 second or 5 seconds  
DIP switches selectable
- Power supply 24 Vac/dc
- IP ratings  
IP65 for enclosure  
IP10 for probe
- Duct mounting flange with neoprene gasket  
for good sealing into the duct and  
to adjust the penetration probe depth

### Extra features for AVT 251 MDR2B and AVT 551 MDR2B

- Modbus RS485 communication
- LCD Display
- 2 x relay outputs
- Buzzer

### On request :

- Output 2-10 Vdc, 0-5 Vdc and 1-5 Vdc
- Output number 2 (AO2) can be supplied as  
Temperature output instead of Air Velocity output.
- Other combination AVT types on next page

## Applications

- Duct sensor for air velocity measurement in  
HVAC systems.
- Measurement in ventilation ducts
- For control, surveillance, and regulation of the flow  
rate in fresh-air and ventilation systems, etc.
- HVAC supply or extract air measuring
- Clean room monitoring and control etc

## Ordering codes

Type	Range	Air Velocity Output (AO1)	Air Velocity Output (AO2)	Options	Advanced options
AVT	2 = 0-5 m/s 0-10 m/s 0-15 m/s 0-20 m/s  5 = 0-1 m/s 0-2 m/s 0-3 m/s 0-5 m/s	0 = no output  1 = 0-10 Vdc  2 = 2-10 Vdc  3 = 0-5 Vdc  4 = 1-5 Vdc  5 = 4-20 mA	0 = no output  1 = 0-10 Vdc  2 = 2-10 Vdc  3 = 0-5 Vdc  4 = 1-5 Vdc  5 = 4-20 mA	M = Modbus RS485  D = LCD display  R2 = 2 x Relay outputs  B = Buzzer	P = PID out  T = RTC  R = Datalogger

- 1.. For a fine temperature measurement air velocity should be higher than 1 m/s
- 2.. AO1 is always for Air Velocity output
- 3.. AO2 is Air Velocity output as standard. On request Temperature output.
- 4.. Relay and Buzzer options should have be ordered with Display option
- 5.. For advanced options and special applications, please contact with us

## Ordering examples

### AVT 251

Air Velocity transmitter  
 Ranges 0-5 m/s, 0-10 m/s, 0-15 m/s or 0-20 m/s, DIP switches selectable  
 Output 1 (AO1) : 4-20 mA  
 Output 2 (AO2) : 0-10 Vdc

### AVT 551

Air Velocity transmitter  
 Ranges 0-1 m/s, 0-2 m/s, 0-3 m/s or 0-5 m/s, DIP switches selectable  
 Output 1 (AO1) : 4-20 mA  
 Output 2 (AO2) : 0-10 Vdc

### AVT 251 MDR2B

Air Velocity transmitter  
 Ranges 0-5 m/s, 0-10 m/s, 0-15 m/s or 0-20 m/s, DIP switches selectable  
 Output 1 (AO1) : 4-20 mA  
 Output 2 (AO2) : 0-10 Vdc  
 Modbus RS485 communication  
 LCD Display  
 2 x Relay outputs  
 Buzzer

### AVT 551 MDR2B

Air Velocity transmitter  
 Ranges 0-1 m/s, 0-2 m/s, 0-3 m/s or 0-5 m/s, DIP switches selectable  
 Output 1 (AO1) : 4-20 mA  
 Output 2 (AO2) : 0-10 Vdc  
 Modbus RS485 communication  
 LCD Display  
 2 x Relay outputs  
 Buzzer

AVT 251, AVT 551, AVT 251 MDR2B and AVT 551 MDR2B are standard types and can be ordered one piece if required.

Other AVT types than AVT 251, AVT 551, AVT 251 MDR2B and AVT 551 MDR2B can be ordered in minimum 25 pcs per each type.

---

## Technical data

Electrical	Power Supply	24 Vac ( $\pm$ %5), 50-60 Hz 15-35 Vdc	
	Power Consumption	< 2.5 W	
Outputs	Current Output	4-20 mA, maximum 500 $\Omega$	
	Voltage Output	0-10 Vdc, minimum 1.000 $\Omega$ 0-5 Vdc, minimum 1.000 $\Omega$	
	Relay Output	max. rating 1A @ 220 Vac	
Accuracy	Air Velocity	$\pm$ 5 % for 0-20 m/s	
	Temperature	0.5°C at min 1 m/s	
General Data	Sensing Element	Hotwire PT1200	
	Media	Air or non-aggressive gasses	
	Operating Temperature	-25 to +70°C	
	Storage Temperature	-30 to +85°C	
Ranges	Air Velocity		
	AVT 2	0-5 m/s 0-10 m/s 0-15 m/s 0-20 m/s	
	AVT 5	0-1 m/s 0-2 m/s 0-3 m/s 0-5 m/s	
	Temperature	-30 to +70°C and 0 to +100°C	
	Connections	X1-X2Terminals X3 terminals Cable Cable Gland	Pluggable screw terminal Fixed screw terminal maximum 1.5mm <sup>2</sup> M16
	Protection	Enclosure Probe	IP65 IP10
Standards	EMC Directive CE Conformity	EN 61326-1 CE1708	
Dimensions	Enclosure Probe	98.0 x 81.5 x 45.5 mm diameter 13 mm, length 255 mm	
Packing (carton) dimensions	100 x 90 x 330 mm		
Weight Packed	270 grams		

## General Notes

- 1.. High density of humidity may effect the measurements.
  - 2.. Observe maximum permissible cable lengths.
  - 3.. If cable runs parallel to the mains cable: Use shielded cables.
  - 4.. Never test with flammable gasses.
  - 5.. The cable entry always should have to be pointing downwards.
  - 6.. The data indicated under 'Technical Data' apply only to vertically mounted transmitters.
  - 7.. Transmitters should be far away from humidifiers, min. 2 meters.
-



## Response Time Setting

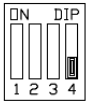
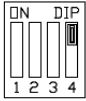



Please check if there is any special instruction on the enclosure or inside the cover

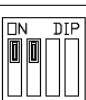

DIP	Response Time
	5 sec
	1 sec

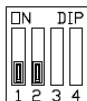
## Range Settings

Please check if there is any special instruction on the enclosure or inside the cover

DIP	AVT 5 ranges
	0...5 m/s
	0...3 m/s
	0...2 m/s
	0...1 m/s

DIP	AVT 2 ranges
	0...20 m/s
	0...15 m/s
	0...10 m/s
	0...5 m/s

DIP	Temp. Ranges
	-30 ...+70°C
	0 ...+100°C

On request output number 2 (AO2) can be supplied as Temperature output instead of Air Velocity output.

## Electrical Connections

- 1.. Please be sure about current direction for current outputs and polarity for voltage outputs.
- 2.. Relay contact is Normally Open and rating is max. 1A at 230VAC
- 3.. We kindly advise using 24V for avoiding high voltage harmonics and external power relay for bigger loads
- 4.. Please use shielded and twisted paired cables for Modbus connections
- 5.. Please observe RS485 termination rules, max. 32 devices in a single Modbus line

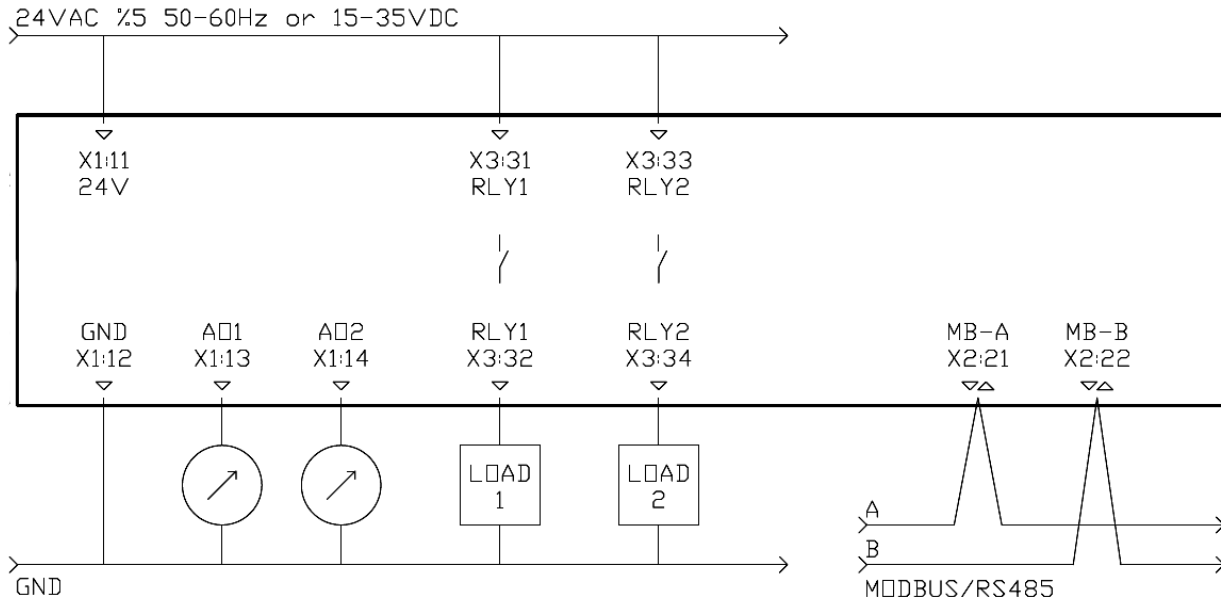

## Transmitter Hardware

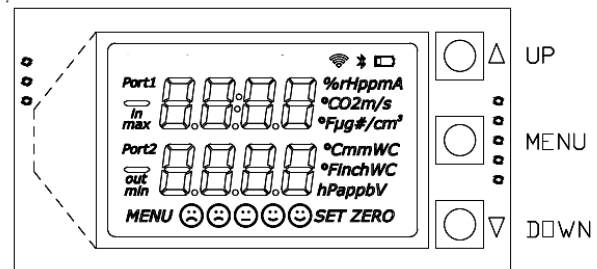
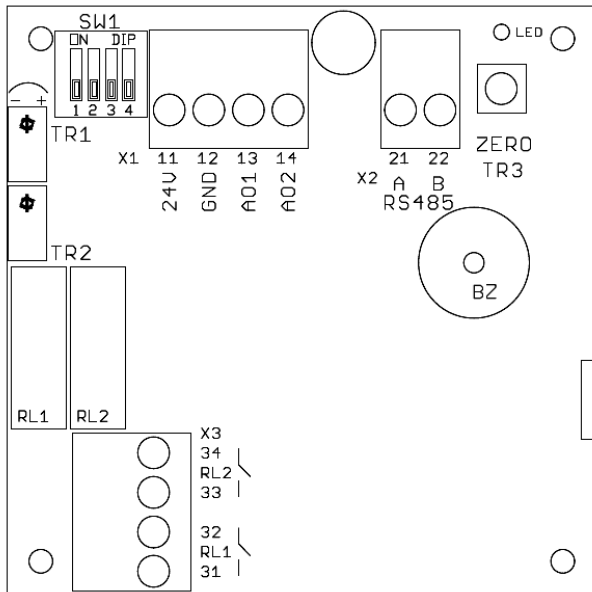

**SW1** DIP Switch for configuration range and response time

### X1 TERMINAL

<b>11</b>	24V	15...35 Vdc or 24 Vac ( $\pm$ %5, 50-60 Hz)
<b>12</b>	GND	ground for power and reference for outputs
<b>13</b>	AO1	analog output 1
<b>14</b>	AO2	analog output 2

### X2 TERMINAL

<b>21</b>	A / RS485	modbus communication positive pair
<b>22</b>	B / RS485	modbus communication negative pair

**LED** bead LED, periodically lights ON and OFF  
modbus communication, blinks when there is a communication

**TR1** span trimmer for AV

**TR2** offset trimmer for temperature

**ZERO / TR3** zero button for AV

**RL1 & RL2** relay 1 and relay 2

**BZ** buzzer

### X3 TERMINAL

<b>31-32</b>	NO - RL1	relay 1 dry contact max. rating 1A @ 220 Vac
<b>33-34</b>	NO - RL2	relay 2 dry contact max. rating 1A @ 220 Vac

## Display and Buttons

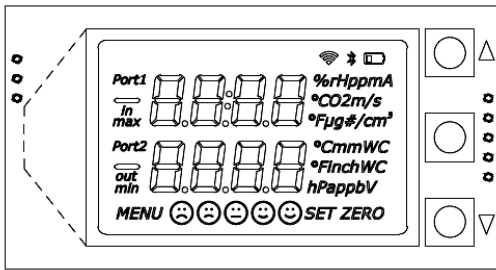

UP

*press for increasing the value or choosing the next parameter*

MENU

*press and wait to enter MENU,  
click to navigate between sub menus one by one*

DOWN

*press for decreasing the value or choosing the previous parameter*

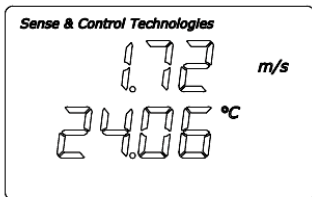

*main screen  
transmitter is working*



*keep pressing MENU button until seeing SET  
transmitter is not working in MENU mode*

Parameters for Relay and Buzzer

Main Screen >> r1 P >> r1 L >> r1 H >> r1 A >>  
 >> r2 P >> r2 L >> r2 H >> r2 A >>  
 >> BP >> BL >> BH >> BA >> Main Screen

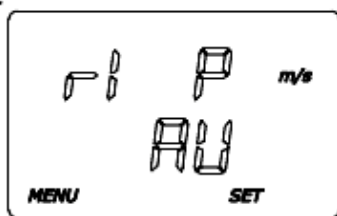

PARAMETER selection for Relay 1

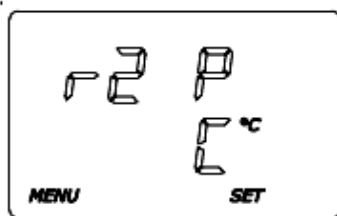

PARAMETER selection for Relay 2

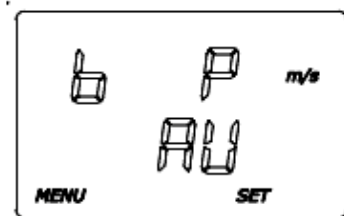

PARAMETER selection for Buzzer

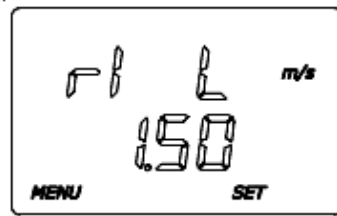

LOW set point for Relay 1

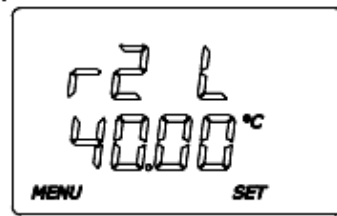

LOW set point for Relay 2

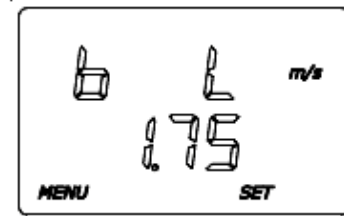

LOW set point for Buzzer

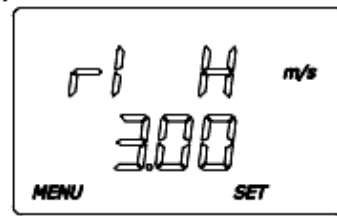

HIGH set point for Relay 1

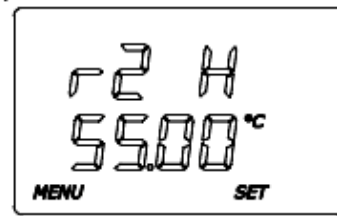

HIGH set point for Relay 2

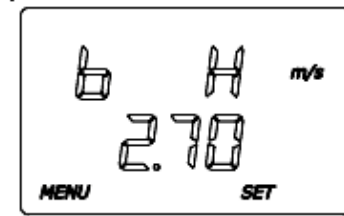

HIGH set point for Buzzer

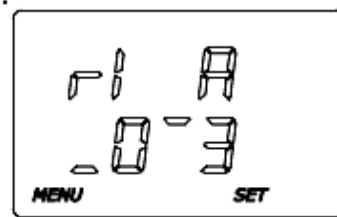

ACTION selection for Relay 1

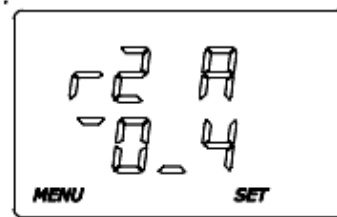

ACTION selection for Relay 2

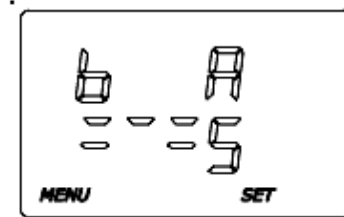

ACTION selection for Buzzer



### Actions for Relay and Buzzer

- action 0, valid for relays and buzzer,  
 relay contact is always OPEN  
 buzzer is always SILENCE
- action 1, valid for relays and buzzer,  
 relay contact is CLOSED between points, OPEN under LOWpoint and OPEN over HIGHpoint  
 buzzer is WARNING between points, SILENCE under LOWpoint and SILENCE over HIGHpoint
- action 2, valid for relays and buzzer,  
 relay contact is OPEN between points, CLOSED under LOWpoint and OPEN over HIGHpoint  
 buzzer is SILENCE between points, WARNING under LOWpoint and SILENCE over HIGHpoint
- action 3, valid for relays and buzzer,  
 relay contact is CLOSED over HIGHpoint, OPEN under LOWpoint, hysteresis between points  
 buzzer is WARNING over HIGHpoint, SILENCE under LOWpoint, hysteresis between points
- action 4, valid for relays and buzzer,  
 relay contact is OPEN over HIGHpoint, CLOSED under LOWpoint, hysteresis between points  
 buzzer is SILENCE over HIGHpoint, WARNING under LOWpoint, hysteresis between points
- action 5, valid only for buzzer,  
 buzzer is WARNING over HIGHpoint, SILENCE under LOWpoint,  
 buzzer is WARNING intermittently between points,
- action 6, valid only for buzzer,  
 buzzer is WARNING under LOWpoint, SILENCE over HIGHpoint,  
 buzzer is WARNING intermittently between points,
- action 7, valid only for buzzer,  
 buzzer is following relay 1 contact,  
 buzzer is WARNING when relay 1 contact is CLOSED, SILENCE when the contact is OPEN
- action 8, valid only for buzzer,  
 buzzer is following relay 2 contact,  
 buzzer is WARNING when relay 2 contact is CLOSED, SILENCE when the contact is OPEN

ACTIONS	under LOW	between LOW & HIGH	over HIGH
0 : 0.0.0	Open / Silence	Open / Silence	Open / Silence
1 : 0.1.0	Open / Silence	Closed / Warning	Open / Silence
2 : 1.0.1	Closed / Warning	Open / Silence	Closed / Warning
3 : 0.X.1	Open / Silence	Hysteresis	Closed / Warning
4 : 1.X.0	Closed / Warning	Hysteresis	Open / Silence
6 : 0.-.1	Silence	Pre Alarm	Warning
6 : 1.-.0	Warning	Pre Alarm	Silence
7 : =r1	Silence when RL1 is Open, Warning when RL1 is Closed		
8 : = r2	Silence when RL2 is Open, Warning when RL2 is Closed		

- 0 : Relay Contact is OPEN, Buzzer is in Silent mode
- 1 : Relay Contact is CLOSED, Buzzer is in Warning mode
- X : Relay Contact is at HYSTERESIS position, OPEN if previous position open, CLOSED if previous position closed
- : Buzzer is in HYSTERESIS mode, Silent if previous mode is silent, Warning if previous mode is warning
- : Buzzer is in PRE ALARM mode, Buzzer is warning intermittently

## Modbus RS485 Protocol

Default Settings: Modbus ID:1, 9600, 8bit, None, 1.

Register Table starts from Base 1.

Use Function 3 for Reading and Function 6 for Writing Holding Registers.

Whenever writing to any Modbus Parameter, the new parameter is activated instantly and you should have to configure the master device according to new parameters. For every reboot/initializing, Modbus is activated with default parameters for 3 seconds.

After 3 seconds, Modbus is reconfigured according to your parameter settings.

Unlisted registers are for analog output calibrations and some system parameters.

Please do not change unlisted registers.

Register	R/W	Range	Description
1	R & W	1...254	Modbus Address
2	R & W	0...1	Baudrate, 0: 9.600, 1: 19.200
3	R & W	0...3	Bit_Parity_Stop, 0: 8bit_None_1, 1: 8bit_None_2, 2: 8bit_Even_1, 3: 8bit_Odd_1
4	R	0...2.000	AV as m/s x100, divide by 100 for exact value
5	R	-3.000...10.000	TEMP as C x100, divide by 100 for exact value
6	R	0 or 1	Relay 1, contact position, 0: OFF - Contact is Open, 1: ON - Contact is Closed
7	R	0...1.000	Relay 1, LOW point
8	R	0...1.000	Relay 1, HIGH point
9	R	0...4	Relay 1, ACTION
10	R	0 or 1	Relay 2, contact position, 0: OFF - Contact is Open, 1: ON - Contact is Closed
11	R	0...1.000	Relay 2, LOW point
12	R	0...1.000	Relay 2, HIGH point
13	R	0...4	Relay 2, ACTION
14	R	0 or 1	Buzzer, 0: OK-Silence, 1: PreAlarm - warning intermittently, 2: WARNING continuously
15	R	0...1.000	Buzzer, LOW point
16	R	0...1.000	Buzzer, HIGH point
17	R	0...4	Buzzer, ACTION
18-28			set-up parameters, never use, never change..!
29	R	0...2.000	AV as m/s x100, divide by 100 for exact value
30	R	0...3.937	AV as feet/min
31	R	-3.000...10.000	TEMP as C x100, divide by 100 for exact value
32	R	-30...100	TEMP as C
33	R	-2.200...21.200	TEMP as F x100, divide by 100 for exact value
34	R	-22...212	TEMP as F

## Air Velocity Calibration Procedure

### Set-up for Calibration

1. Power the unit and connect the unit with Modbus/RS485,
2. Check response time, response time can be set 1 sec. or 5 sec., it is recommended to set 1 second for any calibration, check page 2 for response time setting,

### ZERO Calibration

3. Close the probe with the original cap and keep the unit working,
4. Wait for about 10 minutes, for measuring the raw value of 0 m/s,
5. Read U0 value from MR\_48, note this value to your records,
6. Write U0 value to MR\_41,
7. Write 9 to MR\_27, this is a must for saving the parameters, MR\_27 value turns to 0 automatically,
8. Remove the cap and you are ready for span calibrations,

### SPAN-1 Calibration, for low AV values

9. After ZERO please do not loose much time,
10. Apply air velocity as much as:  
for AVT 2 series, 5 m/s,  
for AVT 5 series, 1 m/s,
11. You do not need to wait too much, just be sure that you have a stable measurement,
12. Read U50-1 value from MR\_48, note this value to your records,
13. Write U50-1 value to MR\_42,
14. This calibration value is used for the sub-ranges for:  
for AVT 2 series, 5 and 10 m/s,  
for AVT 5 series, 1 and 2 m/s,
15. Write 9 to MR\_27, this is a must for saving the parameters, MR\_27 value turns to 0 automatically,

### SPAN-2 Calibration, for high AV values

16. After SPAN-1 calibration, please do not loose much time,
17. Apply air velocity as much as:  
for AVT 2 series, 10 m/s,  
for AVT 5 series, 2,5 m/s,
18. You do not need to wait too much, just be sure that you have a stable measurement,
19. Read U50-2 value from MR\_48, note this value to your records,
20. Write U50-2 value to MR\_45,
21. This calibration value is used for the sub-ranges for:  
for AVT 2 series, 15 and 20 m/s,  
for AVT 5 series, 3 and 5 m/s,
22. Write 9 to MR\_27, this is a must for saving the parameters, MR\_27 value turns to 0 automatically,

### Other Parameter Setting

23. Please calculate the values for = square root of (V50) X 1.000
24. Typical V50-1 values:  
for AVT 2 series: V50-1 for 5 m/s is 2.236, write it to MR\_43,  
for AVT 5 series: V50-1 for 1 m/s is 1.000, write it to MR\_43,
25. Typical V50-2 values:  
for AVT 2 series: V50-2 for 10 m/s V50 is 3.162, write it to MR\_46,  
for AVT 5 series: V50-2 for 2,5 m/s is 1.581, write it to MR\_46,
26. Write 9 to MR\_27, this is a must for saving the parameters, MR\_27 value turns to 0 automatically,
27. Calibration is done.

### Notes:

28. Please do not un-power the unit while calibration,
29. Please use filtered clean air while applying air velocity,
30. Please re-power the unit and check the parameters that you set,

### Air Velocity Calibration Parameters

Below you can find the Modbus/RS485 Register List for Calibration Parameters. These parameters are so important for fine working. Please do not change any parameter unless re-calibration.

Register	R/W	Code	Description
27	R & W		Write 0 for saving calibration parameters
41	R	U <sub>0</sub>	Raw Value at 0 m/s
42	R & W	U <sub>50-1</sub>	Raw Value for the lower calibration point
43	R & W	V <sub>50-1</sub>	Air Velocity for the lower calibration point
44	R	K <sub>av-1</sub>	K constant for the lower calibration point, calculated automatically
45	R & W	U <sub>50-2</sub>	Raw Value for the higher calibration point
46	R & W	V <sub>50-2</sub>	Air Velocity for the higher calibration point
47	R	K <sub>av-2</sub>	K constant for the higher calibration point, calculated automatically
48	R	U <sub>x</sub>	Raw Value of the sensing element
49	R	AV	Air Velocity x1.000, divide 1.000 for actual value, in m/sec.
50	R		blank

### Temperature Calibration

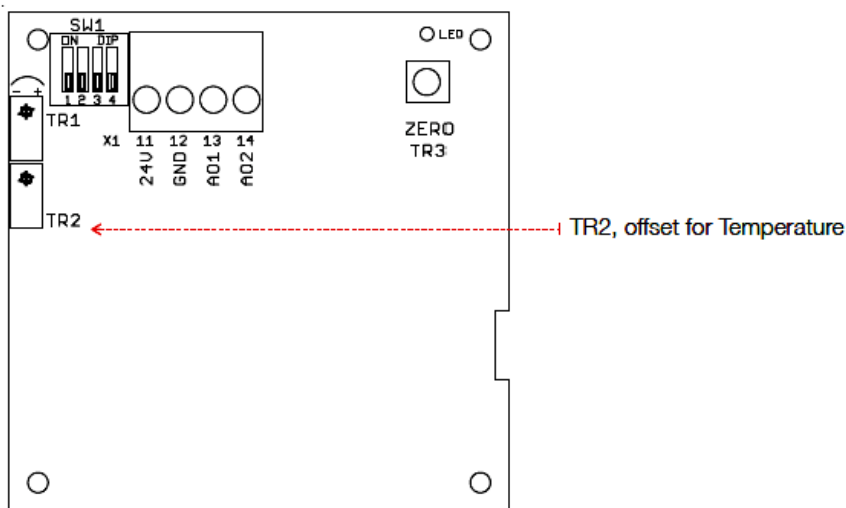

### OFFSET for Temperature

1. Apply air flow min. 1 m/sec
2. Adjust the TR2 trimmer while reading analog out or display

**Drawing / Dimensions**

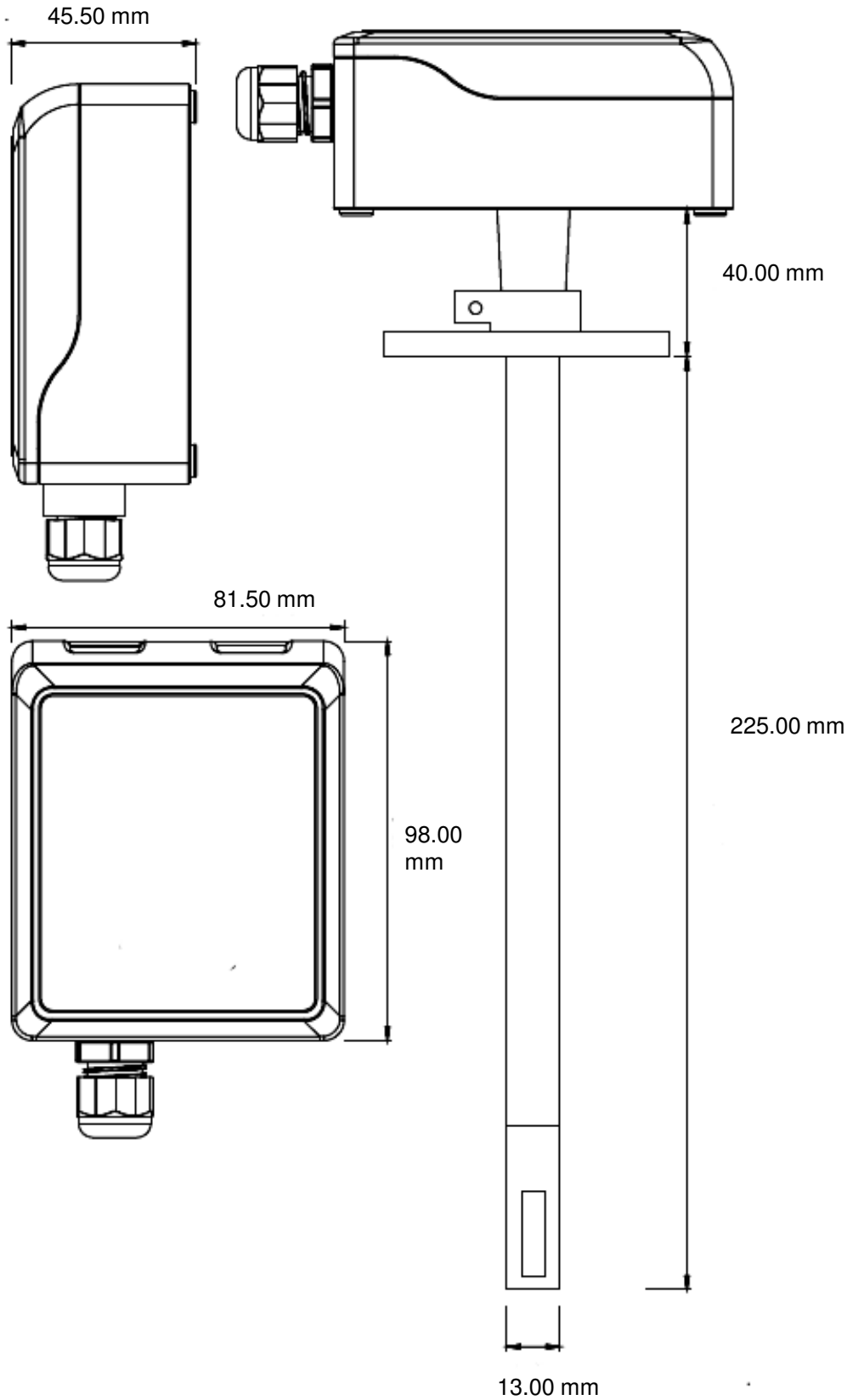

We reserve the right to make changes in our products without any notice which may effect the accuracy of the information contained in this leaflet.