

V-Series Inclinometer



- Single or dual axis inclinometer
- Measurement range $\pm 5^\circ$ $\pm 15^\circ$ and $\pm 45^\circ$
- analogue voltage or current output signal
- AL-housing IP 65

DESCRIPTION

The **V-Series** of conductive single or dual axis inclinometers offers a modern electronic in an environmentally protected and robust aluminium anodizing housing. This fully calibrated inclinometer is available with an analogue voltage output signals or current output signal. They have a compact study design and show large range of applications are possible.

FEATURES

- Single or dual axis inclinometer
- Analogue voltage or current output signal
- Easy to mounted
- High resolution
- Protection class IP 65
- Rugged M9 7 pins connector
- Robust AL-housing

APPLICATIONS

- Drilling machines
- Vehicle applications
- Building control
- Mobile and stationary cranes
- Hydraulic leveling
- Platform leveling
- Road construction machines

V-Series Inclinator

PERFORMANCE SPECIFICATIONS

	Conditions	Min	Type	Max	Unit
Measurement range		-5 / -15/ -45		+5 / +15/ +45	°
Resolution ⁽¹⁾		0.001		0.01	°
Accuracy	Ta = 0°...70°C,	0.08 / 0.15 / 0.9 ⁽⁴⁾			°
Non-linearity		1.5			%[FS]
Cross sensitivity		0.15			%[FS]
Voltage output signal ^{(2),(3)}	V,V2 unit	-2		+2	V
Voltage output signal ⁽³⁾	V,V2 unit	0.5		4.5	V
Current output signal ⁽³⁾	VI,V2I unit	20		4	mA
Current consumption		10		30	mA
Power supply		+12		+24	VDC
Operation temperature range		0		+70	°C
Storage temperature range		-40		+85	°C
Weight		300		320	g
Dimensions	W x D x H	90 x 60 x 45.5			mm

- (1) depend on measurement range
- (2) ratiometric to signal ground GNDx,y
- (3) depending on the circuitry wiring, see pinning schema
- (4) up to measurement range +/-30°

V-Series Inclinometer

DIMENSIONS [MM]

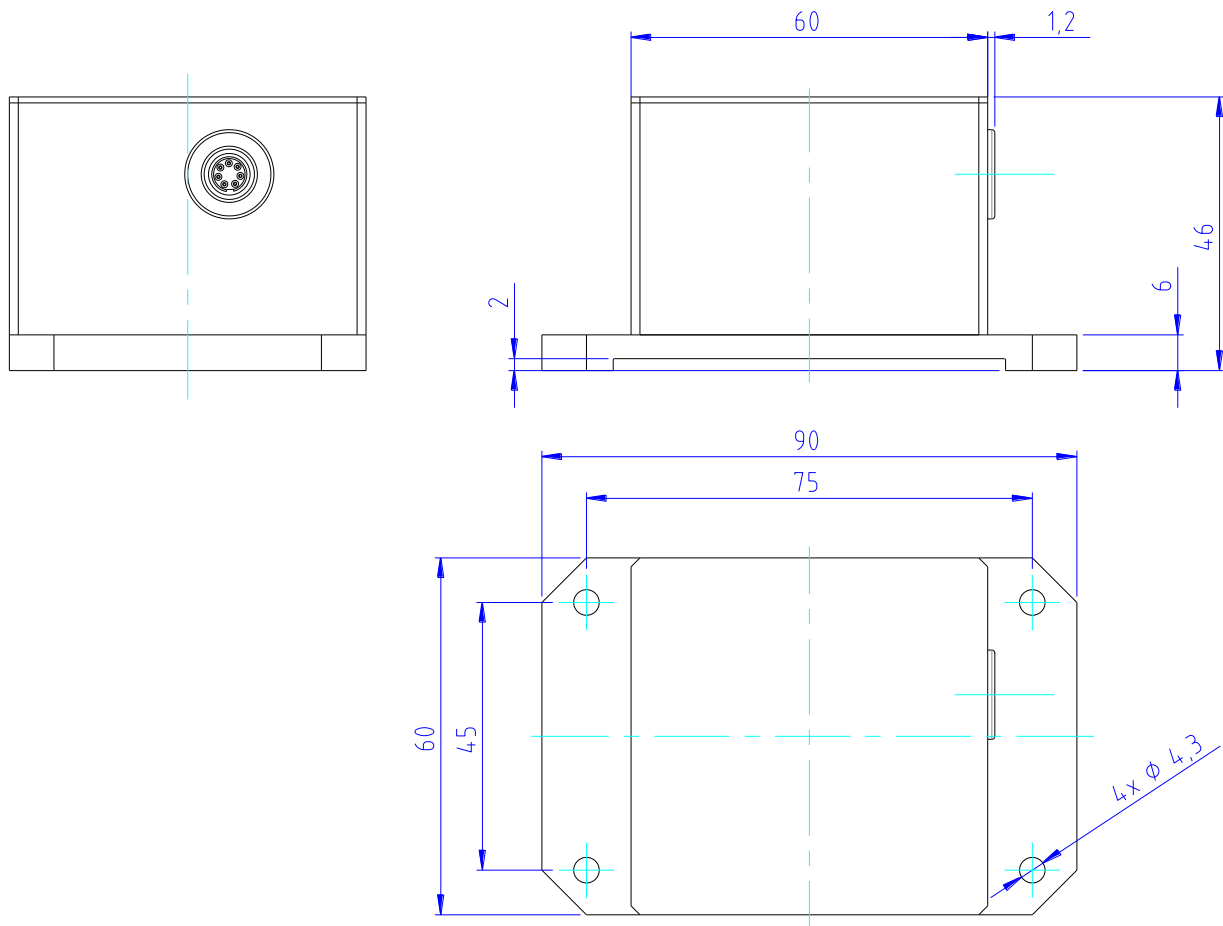

V-Series Inclinometer

PINNING

Pinning single axis unit with voltage output signal: NS-5/V, NS-15/V, NS-45/V

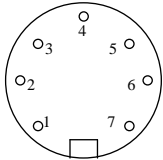

Pin	Name	Description	Type	Color schema(1)
1	Vcc	Positive power supply +12...+24VDC	Supply, Input	white
2	GND	Ground, negative supply voltage	Supply, Input	brown
3	Earth	Protection conductor	Supply, Input	green
4	GNDx	Ground for output voltage signal X axis	Output	yellow
5	n.c.	n.c.	-	grey
6	Out Vx	Output voltage signal X axis	Output	pink
7	n.c.	n.c.	-	blue

(1) by using a Measurement Specialties cable

Output connecting possibility 1

Pin 6 output voltage signal Vx x-axis



Output signal – 2V (- 5°) up to +2V (+ 5°)

Output signal – 2V (-15°) up to +2V (+15°)

Output signal – 2V (-45°) up to +2V (+45°)

Pin 4 GNDx analogue ground x-axis

Output connecting possibility 2

Pin 6 output voltage signal Vx x-axis



Output signal + 0,5V (- 5°) up to + 4,5V (+ 5°)

Output signal + 0,5V (-15°) up to + 4,5V (+15°)

Output signal + 0.5V (-45°) up to + 4,5V (+45°)

Pin 2 GND supply ground

Pinning single axis unit with current output signal: NS-5/VI, NS-15/VI, NS-45/VI

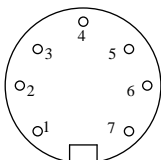

Pin	Name	Description	Type	Color schema(1)
1	Vcc	Positive power supply +12...+24VDC	Supply, Input	white
2	GND	Ground, negative supply voltage	Supply, Input	brown
3	Earth	Protection conductor	Supply, Input	green
4	GNDx	Ground for output current signal X axis	Output	yellow
5	n.c.	n.c.	-	grey
6	Out Ix	Output Current signal X axis	Output	pink
7	n.c.	n.c.	-	blue

(1) by using a Measurement Specialties cable

V-Series Inclinometer

Pinning dual axis unit with voltage output signal: NS-5/V2, NS-15/V2, NS-45/V2

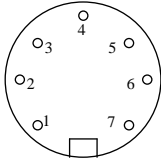

Pin	Name	Description	Type	Color schema(1)
1	Vcc	Positive power supply +12...+24VDC	Supply, Input	white
2	GND	Ground, negative supply voltage	Supply, Input	brown
3	Earth	Protection conductor	Supply, Input	green
4	GNDx	Ground for output voltage signal X axis	Output	yellow
5	GNDy	Ground for output voltage signal Y axis	Output	grey
6	Out Vx	Output voltage signal X axis	Output	pink
7	Out Vy	Output voltage signal Y axis	Output	blue

(1) by using a Measurement Specialties cable

Output connecting possibility 1

Pin 6,7 output voltage signal Vx x-axis, Vy y-axis



Output signal – 2V (- 5°) up to +2V (+ 5°)
Output signal – 2V (-15°) up to +2V (+15°)
Output signal – 2V (-45°) up to +2V (+45°)

Pin 4,5 GNDx,y analogue ground x,y-axis

Output connecting possibility 2

Pin 6,7 output voltage signal Vx x-axis, Vy y-axis



Output signal + 0,5V (- 5°) up to + 4,5V (+ 5°)
Output signal + 0,5V (-15°) up to + 4,5V (+15°)
Output signal + 0.5V (-45°) up to + 4,5V (+45°)

Pin 2 GND supply ground

Pinning dual axis unit with current output signal: NS-5/V2I, NS-15/V2I, NS-45/V2I

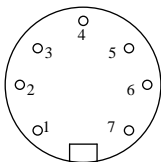

Pin	Name	Description	Type	Color schema(1)
1	Vcc	Positive power supply +12...+24VDC	Supply, Input	white
2	GND	Ground, negative supply voltage	Supply, Input	brown
3	Earth	Protection conductor	Supply, Input	green
4	GNDx	Ground for output current signal X axis	Output	yellow
5	GNDy	Ground for output current signal Y axis	Output	grey
6	Out Ix	Output Current signal X axis	Output	pink
7	Out Iy	Output Current signal Y axis	Output	blue

(1) by using a Measurement Specialties cable

V-Series Inclinator

ORDERING INFORMATION

PART NUMBERING	UNIT	SHORT DESCRIPTION
Single axis unit		
G-NSV-001	NS- 5/V	single axis,range +/- 5°,Vcc 12...24VDC,output V
G-NSVI-001	NS- 5/VI	single axis,range +/- 5°,Vcc 12...24VDC,output I
G-NSV-002	NS-15/V	single axis,range +/-15°,Vcc 12...24VDC,output V
G-NSVI-003	NS-15/VI	single axis,range +/-15°,Vcc 12...24VDC,output I
G-NSV-005	NS-45/V	single axis,range +/-45°,Vcc 12...24VDC,output V
G-NSVI-006	NS-45/VI	single axis,range +/-45°,Vcc 12...24VDC,output I
Dual axis unit		
G-NSV2-001	NS- 5/V2	dual axis,range +/- 5°,Vcc 12...24VDC,output V
G-NSV2I-001	NS- 5/V2I	dual axis,range +/- 5°,Vcc 12...24VDC,output I
G-NSV2-003	NS-15/V2	dual axis,range +/-15°,Vcc 12...24VDC,output V
G-NSV2I-003	NS-15/V2I	dual axis,range +/-15°,Vcc 12...24VDC,output I
G-NSV2-006	NS-45/V2	dual axis,range +/-45°,Vcc 12...24VDC,output V
G-NSV2I-006	NS-45/V2I	dual axis,range +/-45°,Vcc 12...24VDC,output I
Accessories		
G-NSMIS-001	Connection	Connector,straight, Submin. 712-series
G-NSMIS-015	Connection	Connector, angle 90°, Submin. 712-series
G-NSMIS-002	Connection	2 m cable, straight connector Submin. 702-series
G-NSMIS-003	Connection	2 m cable, angle 90° connector Submin. 702-series

Other cable length on request

NORTH AMERICA	EUROPE	ASIA
Measurement Specialties, Inc. 1000 Lucas Way Hampton, VA 23666 United States Phone: +1-800-745-8008 Fax: +1-757-766-4297 Email: sales@meas-spec.com Web: www.meas-spec.com	MEAS Deutschland GmbH Hauert 13 D-44227 Dortmund Germany Phone: +49-(0)231-9740-0 Fax: +49-(0)231-9740-20 Email: info.de@meas-spec.com Web: www.meas-spec.com	Measurement Specialties China Ltd. No. 26, Langshan Road High-tech Park (North) Nanshan District, Shenzhen 518057 China Phone: +86-755-33305088 Fax: +86-755-33305099 Email: info.cn@meas-spec.com Web: www.meas-spec.com

The information in this sheet has been carefully reviewed and is believed to be accurate; however, no responsibility is assumed for inaccuracies. Furthermore, this information does not convey to the purchaser of such devices any license under the patent rights to the manufacturer. Measurement Specialties, Inc. reserves the right to make changes without further notice to any product herein. Measurement Specialties, Inc. makes no warranty, representation or guarantee regarding the suitability of its product for any particular purpose, nor does Measurement Specialties, Inc. assume any liability arising out of the application or use of any product or circuit and specifically disclaims any and all liability, including without limitation consequential or incidental damages. Typical parameters can and do vary in different applications. All operating parameters must be validated for each customer application by customer's technical experts. Measurement Specialties, Inc. does not convey any license under its patent rights nor the rights of others.